

THE LEADING ASSET INTEGRITY MANAGEMENT
& INDUSTRIAL SOLUTIONS COMPANY



REFRACTORY ANCHORS **CATALOGUE**





**DGC HAS BEEN
DESIGNING,
MANUFACTURING
& INSTALLING
STANDARD,
CUSTOM-MADE
HIGH-QUALITY
REFRACTORY
ANCHORS
AS WELL AS A
WIDE RANGE OF ANCHOR
SUPPORTING SYSTEMS
FOR MORE
THAN 35 YEARS.**

CONTENTS

- 01 GULL WING
- 02 VEE WRIGGLE
- 03 VEE
- 04 FIBRE LOCK PIN
- 05 BOX V
- 06 BULL HORN
- 07 V.X.D.B
- 08 V.X.C-SCISSOR CLIP
- 09 ROOF ANCHOR
- 10 CEMENT PLANT SPECIAL
- 11 "C" CLIP
- 12 R6P - SUSPENSION
- 13 Y ANCHOR

GULL WING

G.W.H.W

GULL WING HAND WELD

NOTES

Diameters Available: 5.5mm, 8mm, 10mm, 12mm

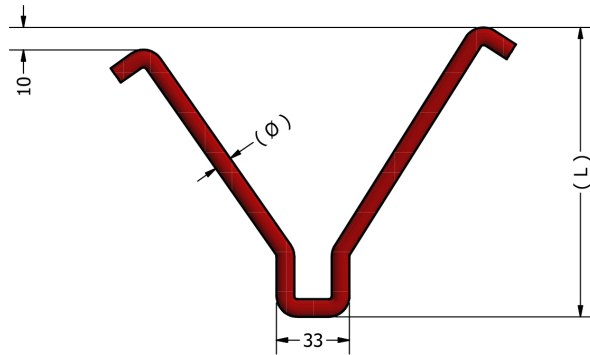

FRONT VIEW

3D VIEW

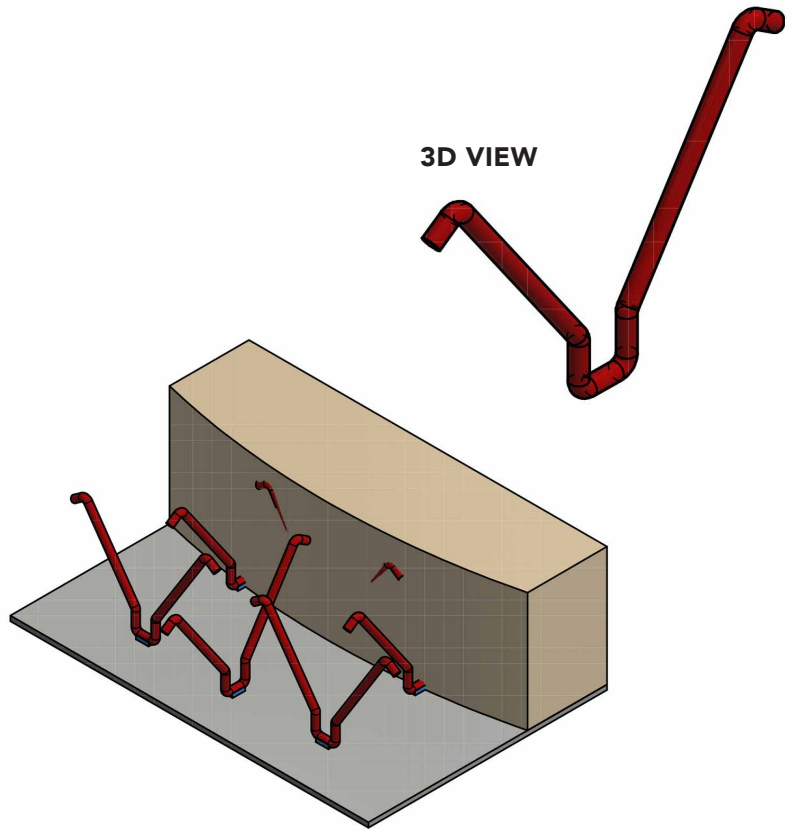

DESIGNATION

MANUFACTURED IN MILD STEEL

304 S/STL

316 S/STL

310 S/STL

253 MA

L = 25mm - 350mm

G.W.S.W

GULL WING STUD WELD

NOTES

Diameters Available: 5.5mm, 8mm

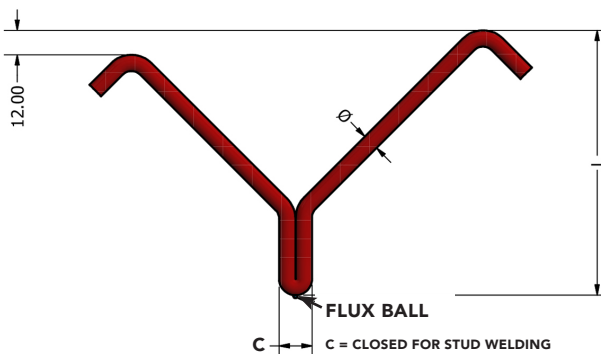

FRONT VIEW

3D VIEW

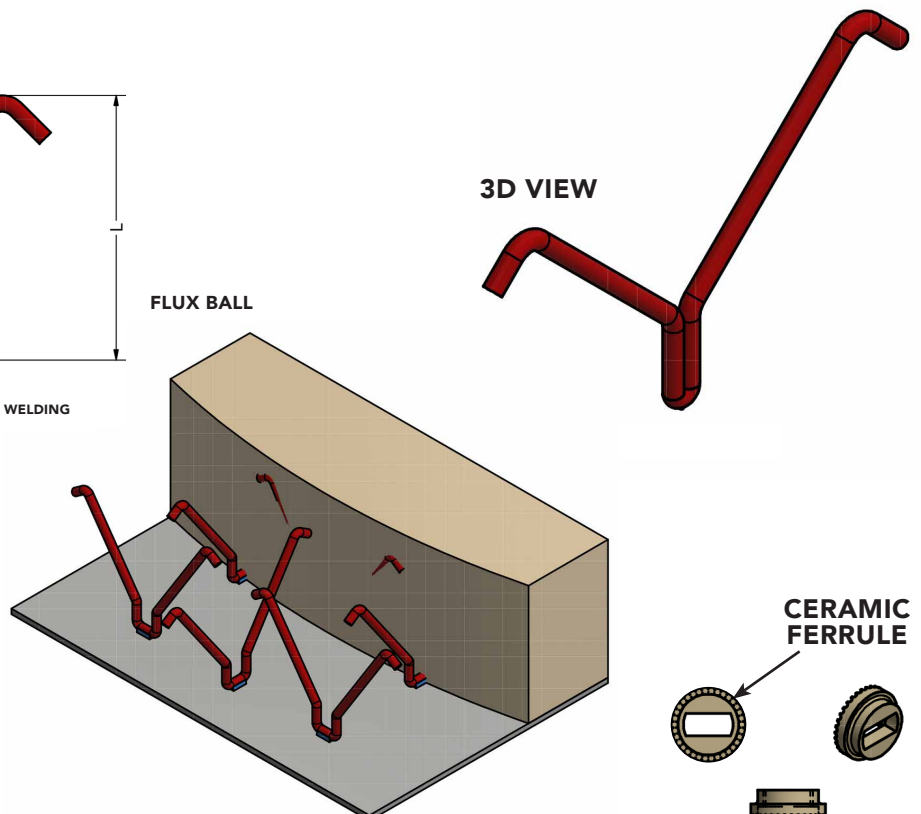

DESIGNATION

MANUFACTURED IN MILD STEEL

304 S/STL

316 S/STL

310 S/STL

253 MA

L = 25mm - 350mm

VEE WRIGGLE

V.X.H.W

VEE WRIGGLE HAND WELD

NOTES

Diameters Available: 5.5mm, 8mm, 10mm, 12mm

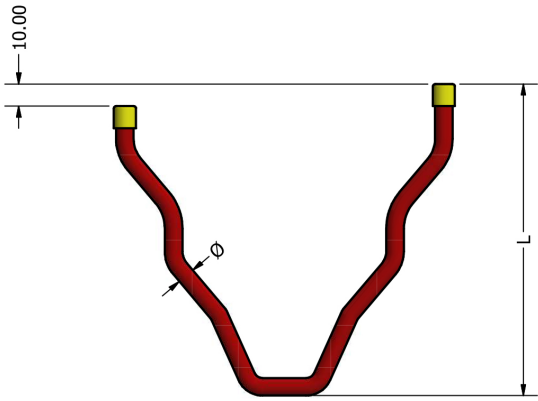

FRONT VIEW

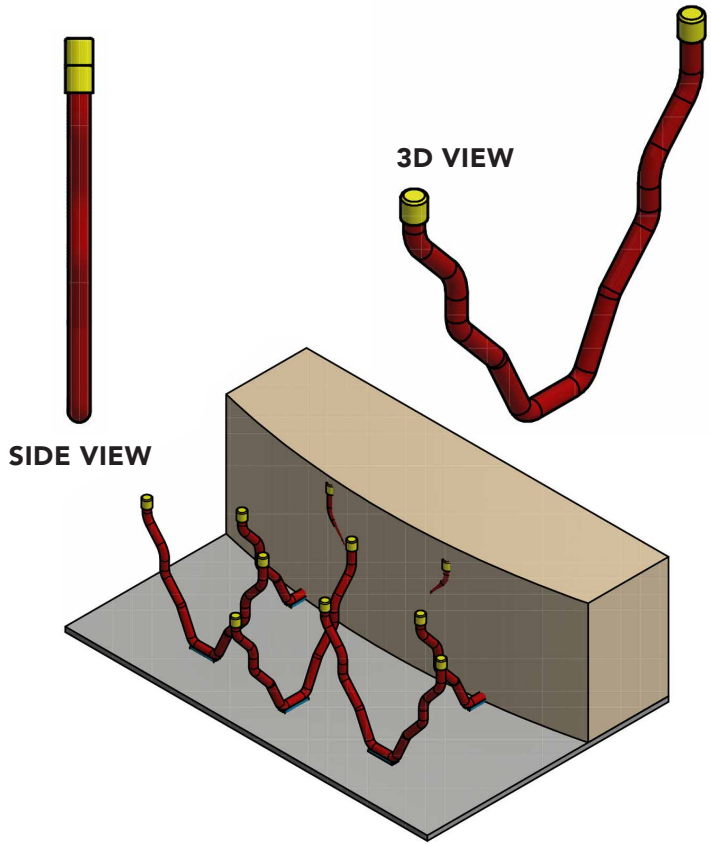

SIDE VIEW

3D VIEW

DESIGNATION

MANUFACTURED IN MILD STEEL

304 S/STL

316 S/STL

310 S/STL

253 MA

L = 25mm - 350mm

V.X.S.W

VEE WRIGGLE STUD WELD

NOTES

Diameters Available: 5.5mm, 8mm

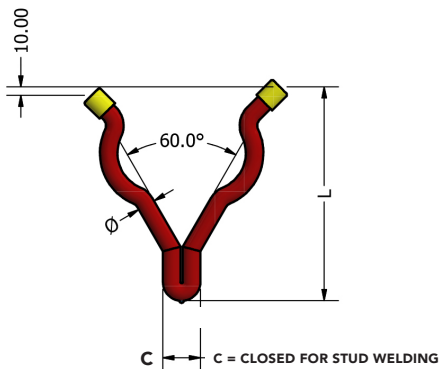

FRONT VIEW

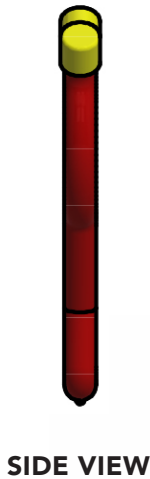

SIDE VIEW

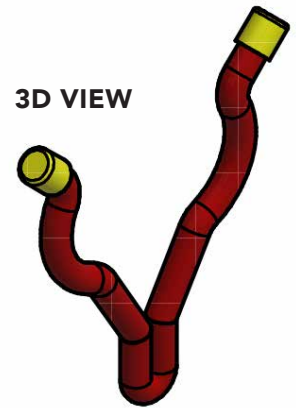

3D VIEW

DESIGNATION

MANUFACTURED IN MILD STEEL

304 S/STL

316 S/STL

310 S/STL

253 MA

L = 25mm - 350mm

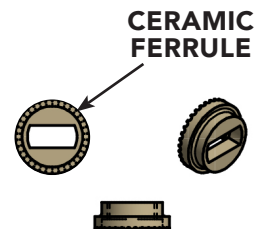
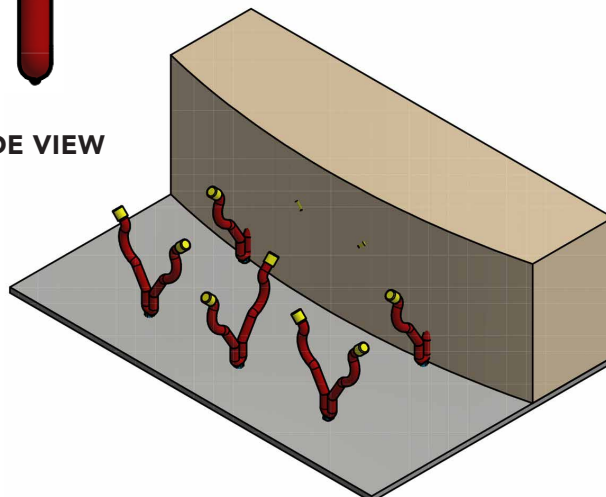

NOTES

Diameters Available: 5.5mm, 8mm, 10mm, 12mm

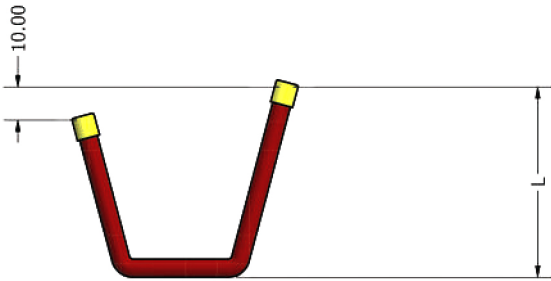

FRONT VIEW



SIDE VIEW

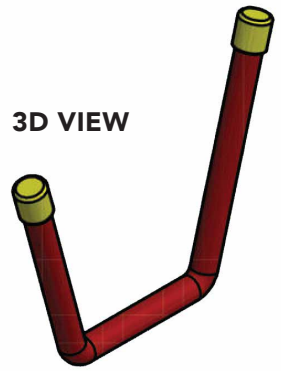

3D VIEW

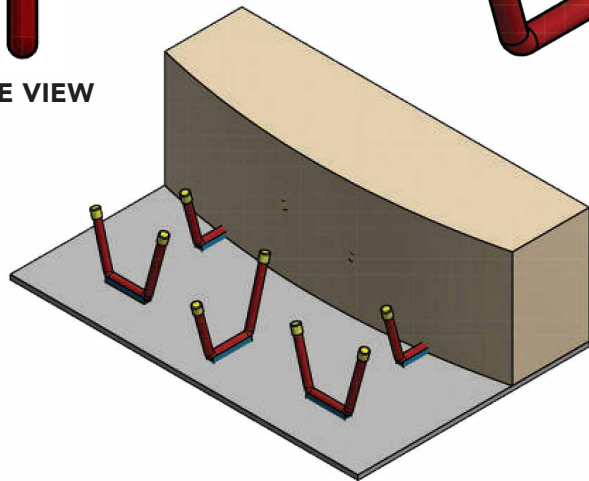

DESIGNATION

MANUFACTURED IN MILD STEEL

- 304 S/STL
- 316 S/STL
- 310 S/STL
- 253 MA

L = 25mm - 350mm

NOTES

Diameters Available: 5.5mm, 8mm

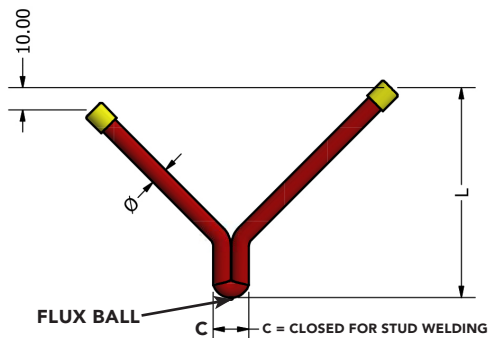

FRONT VIEW



SIDE VIEW

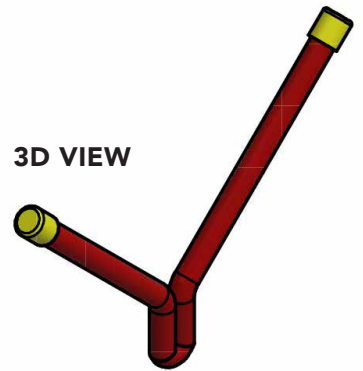

3D VIEW

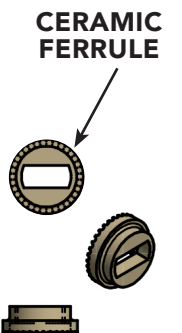
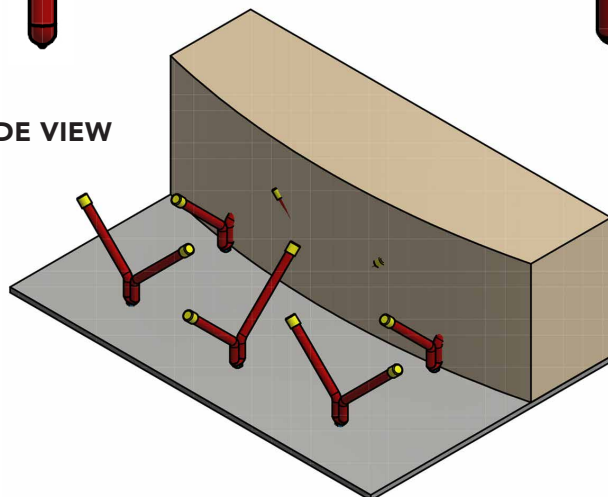

DESIGNATION

MANUFACTURED IN MILD STEEL

- 304 S/STL
- 316 S/STL
- 310 S/STL
- 253 MA

L = 25mm - 350mm

FIBRE LOCK PIN

FIBRE LOCK PIN

NOTES

Diameters Available: 5.5mm

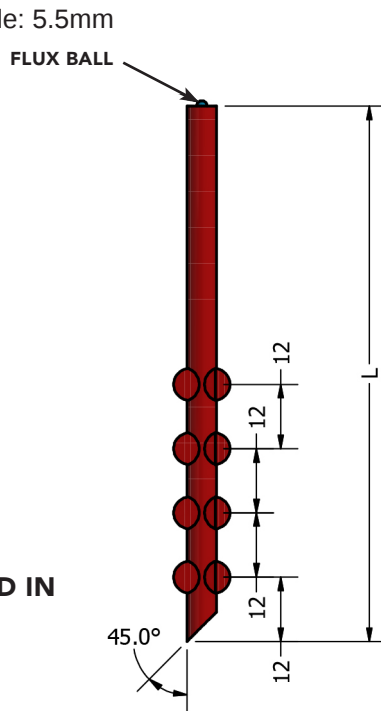

DESIGNATION

MANUFACTURED IN

- 304 S/STL
- 316 S/STL
- 310 S/STL
- 253 MA

L = 25mm - 350mm

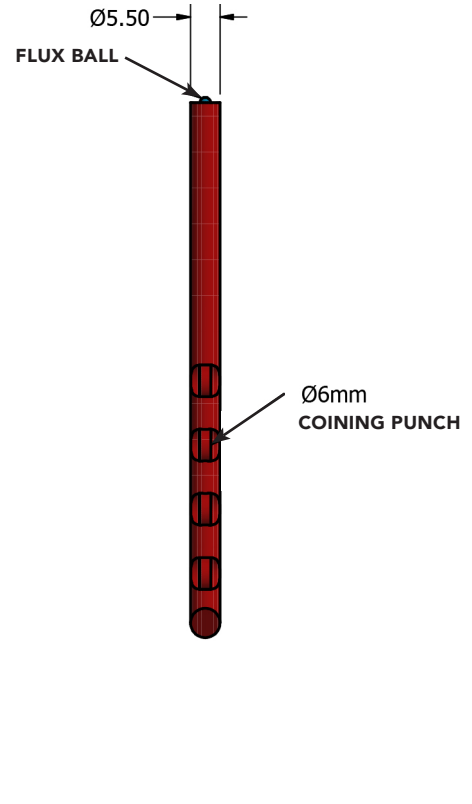

LOCK WASHER FOR FIBRE LOCK PIN

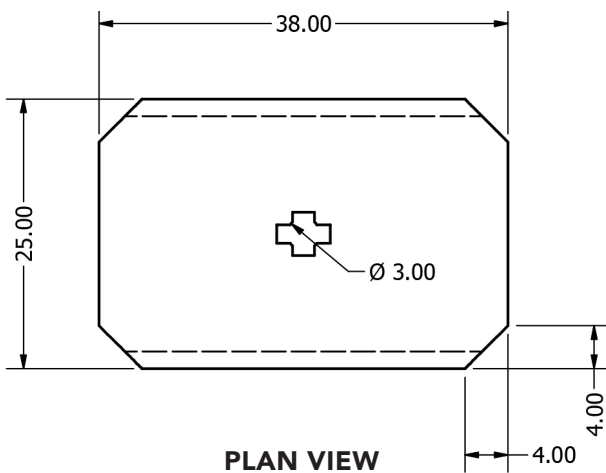

PLAN VIEW

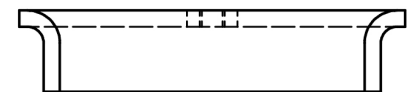

SIDE VIEW

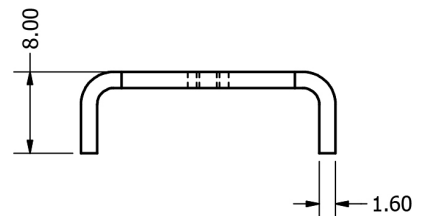

END VIEW

DESIGNATION

MANUFACTURED IN MILD STEEL

- 304 S/STL
- 316 S/STL
- 310 S/STL
- 253 MA

L = 25mm - 350mm

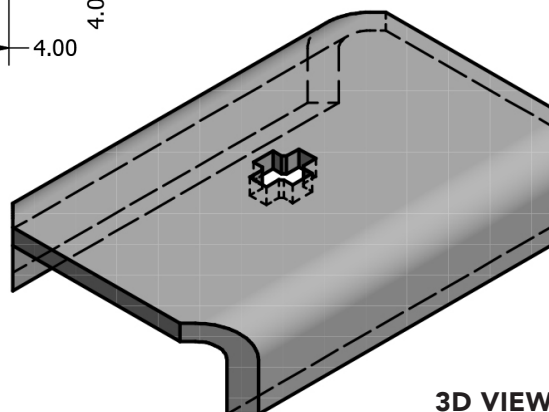

3D VIEW

BOX V

BOLT ON WRIGGLE VEE

NOTES

Diameters Available: 5.5mm, 8mm, 10mm, 12mm

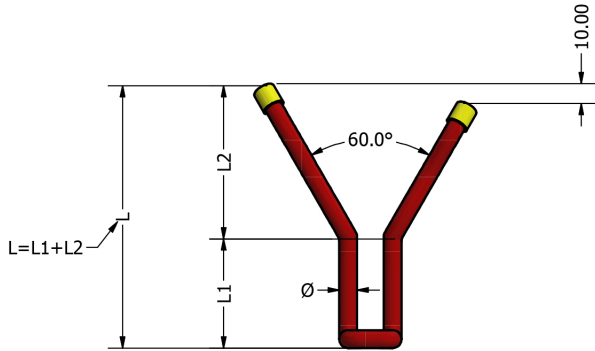

FRONT VIEW



SIDE VIEW



BOTTOM VIEW

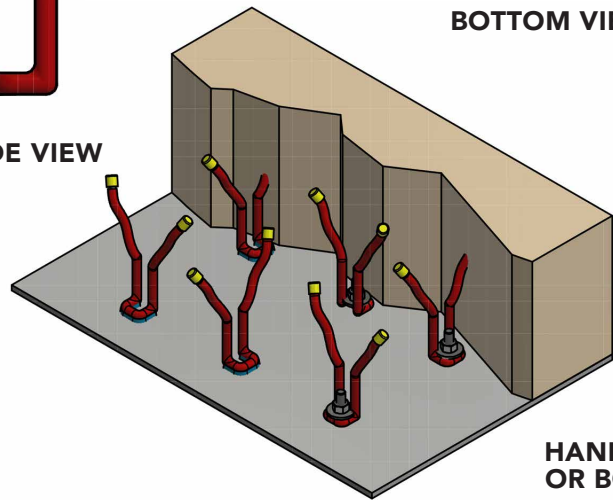

HAND WELD OR BOLT ON

DESIGNATION

MANUFACTURED IN MILD STEEL

304 S/STL

316 S/STL

310 S/STL

253 MA

L = 25mm - 350mm

BOLT ON WRIGGLE VEE

NOTES

Diameters Available: 5.5mm, 8mm, 10mm, 12mm

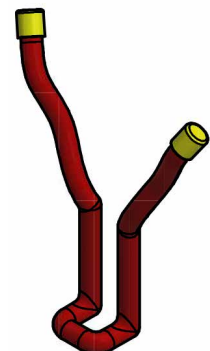
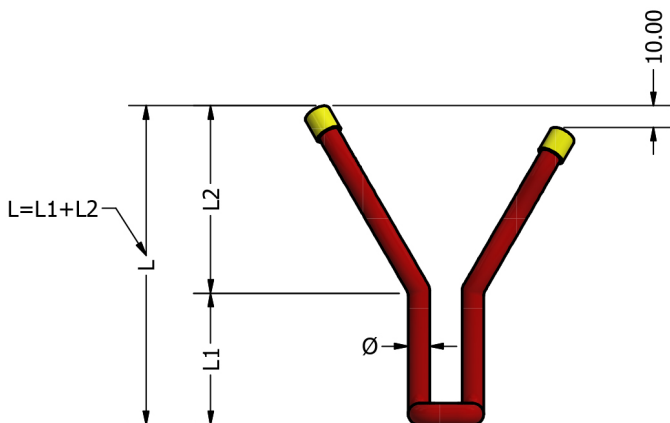

DESIGNATION

MANUFACTURED IN MILD STEEL

304 S/STL

316 S/STL

310 S/STL

253 MA

L = 25mm - 350mm

CERAMIC FERRULES



METRIC HEX NUTS STYLES 2 →



METRIC PLAIN WASHERS →



MB STUD →

FLUX BALL →

BULL HORN

B.H.H.W

BULL HORN HAND WELD

NOTES

Diameters Available: 5.5mm, 8mm, 10mm and 12mm

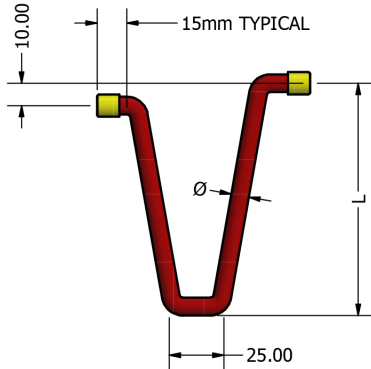

FRONT VIEW



SIDE VIEW

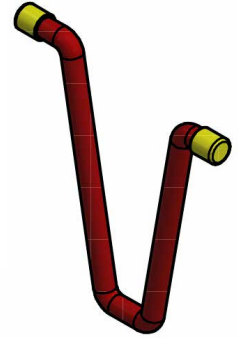

3D VIEW

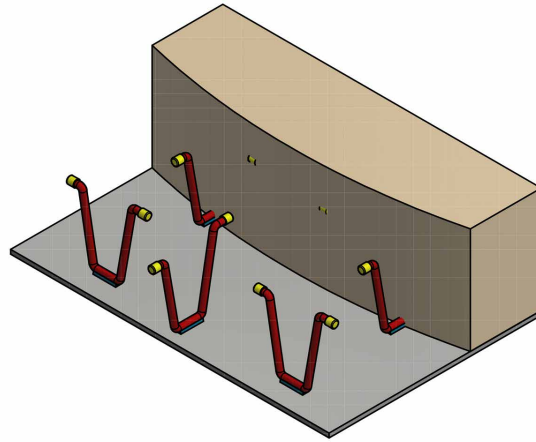

DESIGNATION

MANUFACTURED IN

304 S/STL

316 S/STL

310 S/STL

253 MA

L = 25mm - 350mm

B.H.S.W

BULL HORN STUD WELD

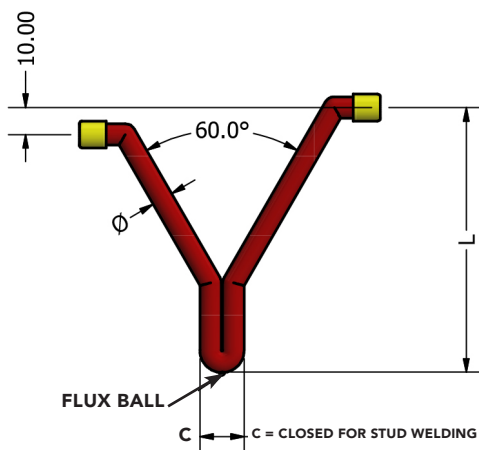

FRONT VIEW



SIDE VIEW

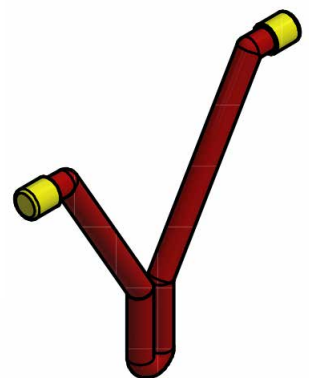

3D VIEW

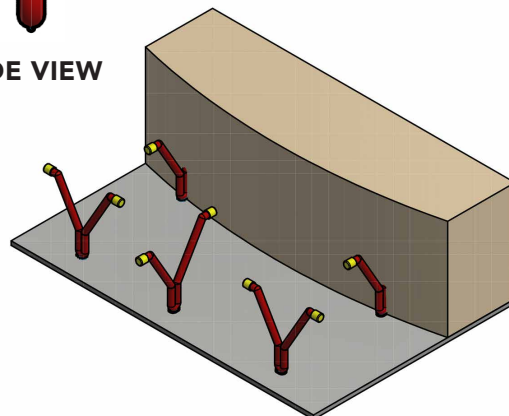

DESIGNATION

MANUFACTURED IN MILD STEEL

304 S/STL

316 S/STL

310 S/STL

253 MA

L = 25mm - 350mm

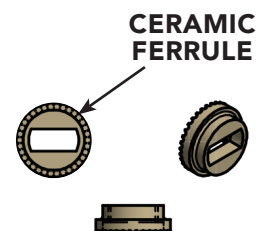

V.X.S.B

VEE WRIGGLE SADDLE BASE

NOTES

Diameters Available: 5.5mm, 8mm and 10mm

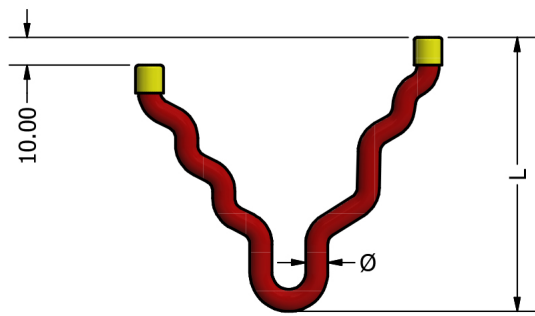

FRONT VIEW



SIDE VIEW

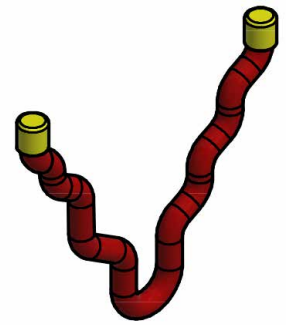

3D VIEW

DESIGNATION

MANUFACTURED IN MILD STEEL

304 S/STL

316 S/STL

310 S/STL

253 MA

L = 25mm - 350mm

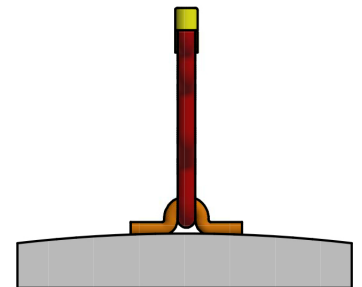
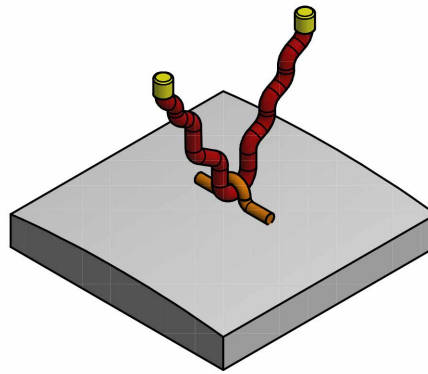

SADDLE MOUNT

V.X.D.B

VEE WRIGGLE DRILLED BASE

NOTES

Diameters Available: 5.5mm, 8mm and 10mm

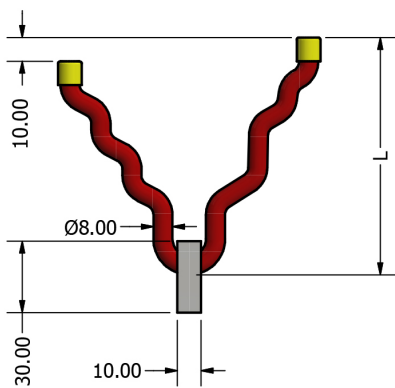

FRONT VIEW



BLACK MOUNT SIDE VIEW

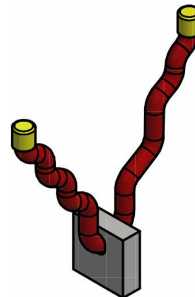

3D VIEW

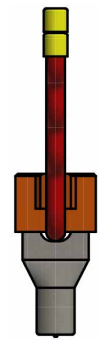

STUDWELD MOUNT

CERAMIC FERRULES



DESIGNATION

MANUFACTURED IN MILD STEEL

304 S/STL

316 S/STL

310 S/STL

253 MA

L = 25mm - 350mm

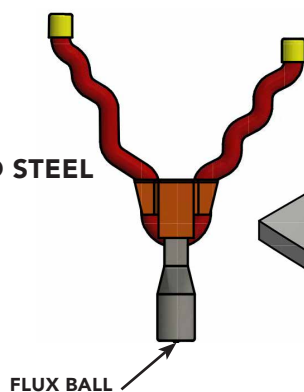

FLUX BALL

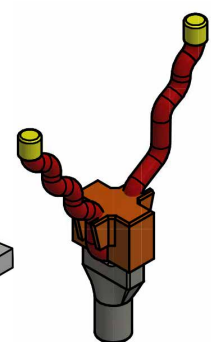
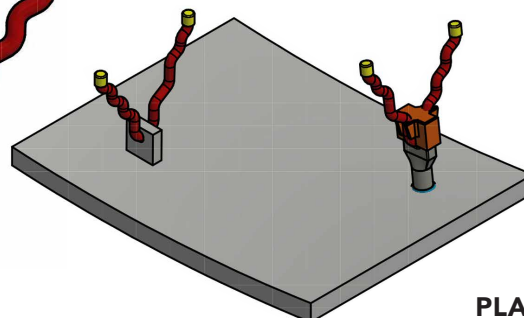

PLASTIC LOCKING CAP

SCISSOR CLIP

V.X.C

CORRUGATED ANCHOR SCISSOR CLIP

NOTES

Diameters Available: 5.5mm, 8mm

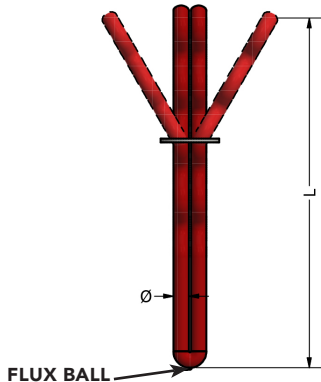

FRONT VIEW



HAND WELD

FRONT VIEW

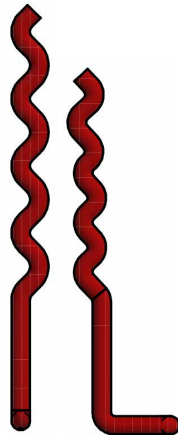

SIDE VIEW



STUD WELD

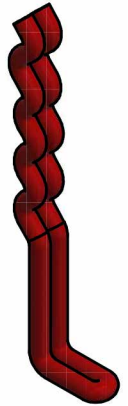

HAND WELD

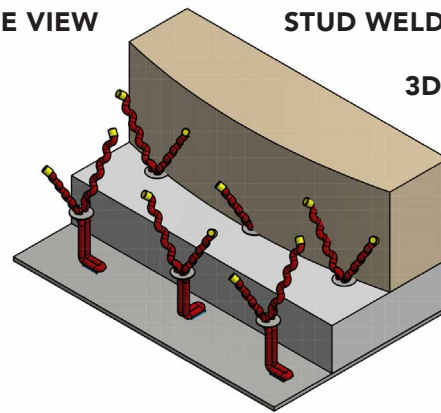

3D VIEW

DESIGNATION

MANUFACTURED IN

304 S/STL

316 S/STL

310 S/STL

253 MA

L = 25mm - 350mm

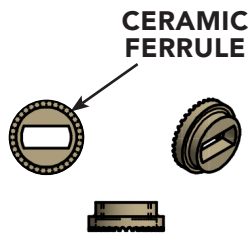

CERAMIC FERRULE

CERMAMIC BRICK HOLDER SCISSOR CLIP

NOTES

Diameters Available: 8mm and 10mm

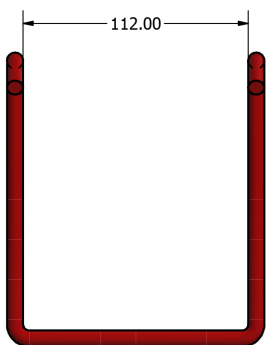

FRONT VIEW

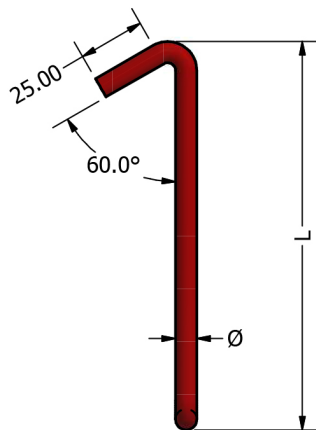

SIDE VIEW

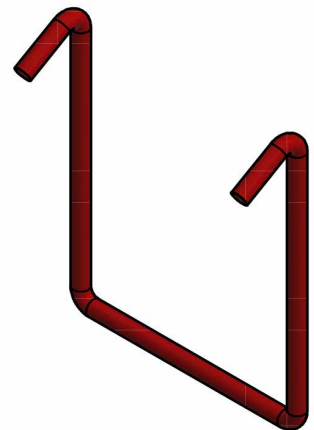

3D VIEW

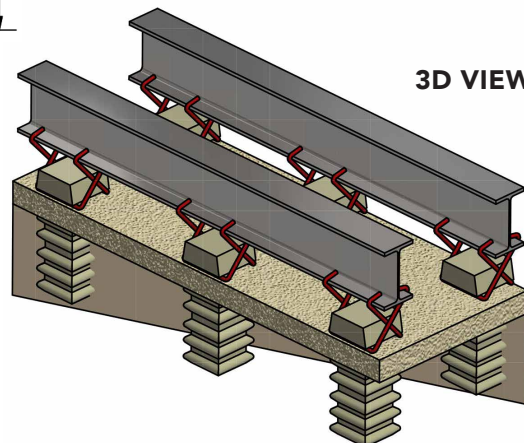

DESIGNATION

MANUFACTURED IN MILD STEEL

304 S/STL

316 S/STL

310 S/STL

253 MA

L = 25mm - 350mm

ROOF ANCHOR

V.X.S.B

HAL-HAR SUSPENSION ANCHOR

NOTES

Diameters Available: 5.5mm, 8mm, 10mm and 12mm

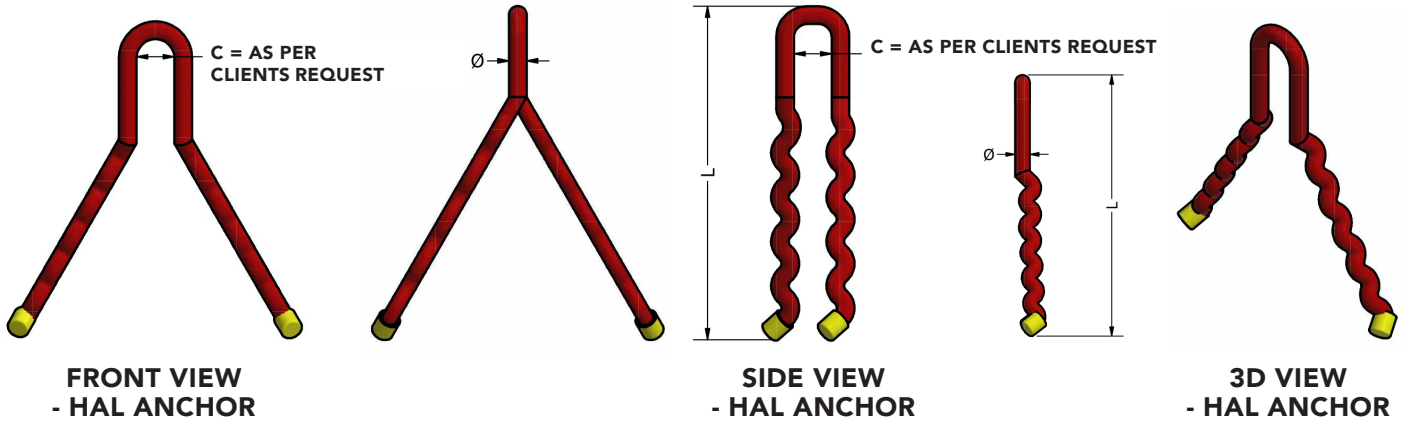

DESIGNATION

MANUFACTURED IN MILD STEEL

304 S/STL

316 S/STL

310 S/STL

253 MA

L = 25mm - 350mm

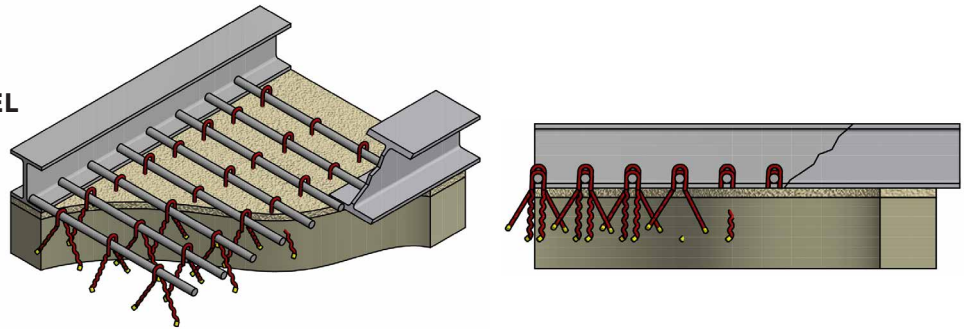

HOLD DOWN BOX ANCHOR

NOTES

Diameters Available: 5.5mm, 8mm and 10mm

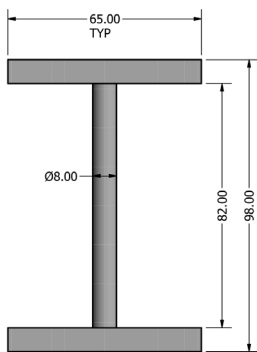

FRONT VIEW

DESIGNATION

MANUFACTURED IN MILD STEEL

304 S/STL

316 S/STL

310 S/STL

L = 25mm - 350mm

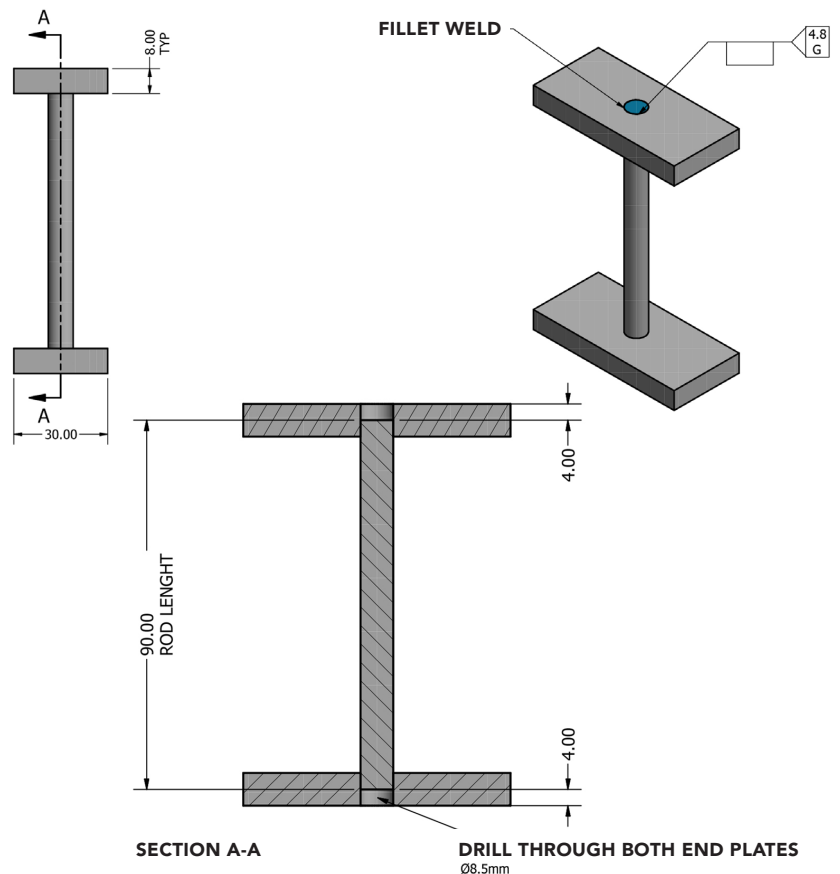

SECTION A-A

DRILL THROUGH BOTH END PLATES
Ø8.5mm

CEMENT PLANT

SPECIAL

ANCHOR CO1 & CO3

NOTES

Diameters Available: 5.5mm, 8mm, 10mm and 12mm

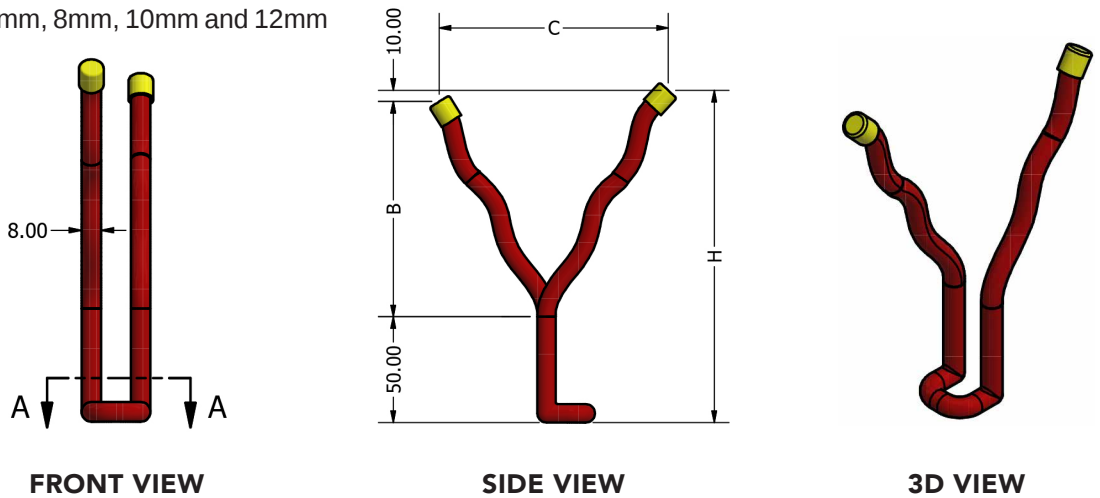

DESIGNATION

MANUFACTURED IN

- 304 S/STL
- 316 S/STL
- 310 S/STL
- 253 MA

L = 25mm - 350mm

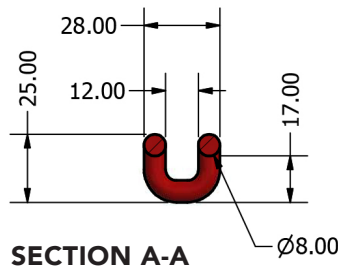

SPECIAL

ANCHOR CO2 & CO4

NOTES

Diameters Available: 5mm, 8mm, 10mm and 12mm

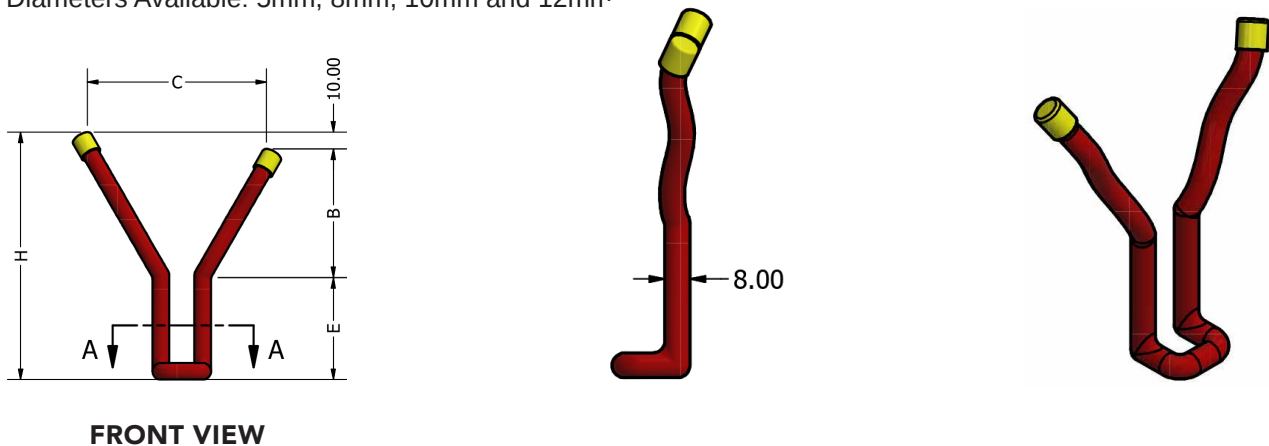

DESIGNATION

MANUFACTURED IN MILD STEEL

- 304 S/STL
- 316 S/STL
- 310 S/STL
- 253 MA

L = 25mm - 350mm

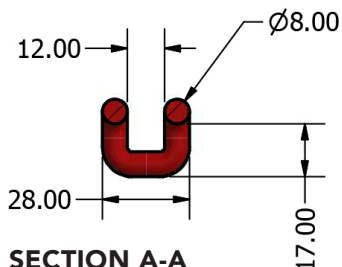

TABLE

1	2	3	4	5
ITEM	E	B	C	H
CO2	50	65	86	115
CO4	75	100	120	150

"C" CLIP

STANDARD "C" CLIP

NOTES

Diameters Available: 5.5mm, 8mm, 10mm and 12mm

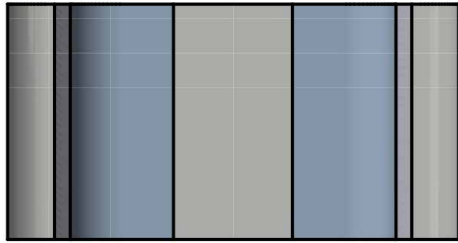

PLAN VIEW

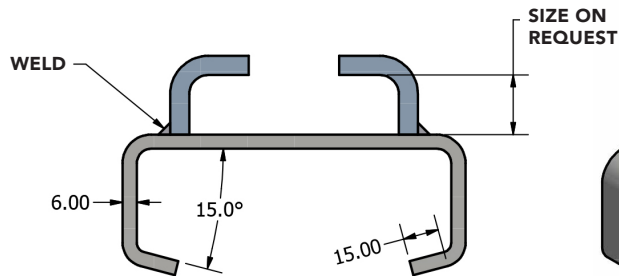

SIDE VIEW

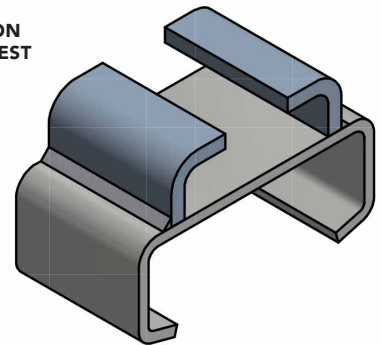

3D VIEW

DESIGNATION

MANUFACTURED IN MILD STEEL

304 S/STL

316 S/STL

310 S/STL

L = 25mm - 350mm

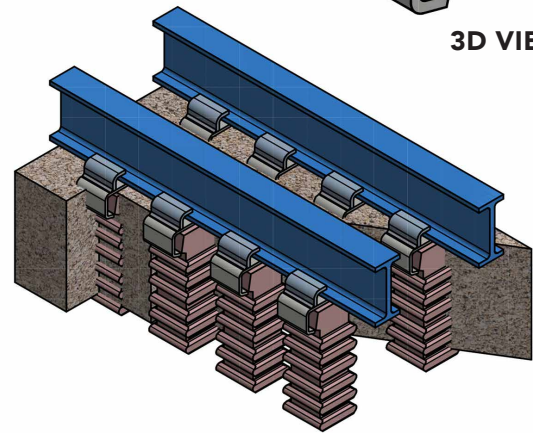
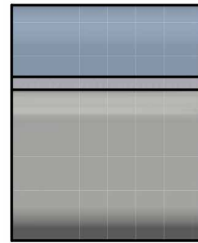

REFRACTORY ANCHORS "C" CLIP TYPES

NOTES

Diameters Available: 5.5mm, 8mm and 10mm

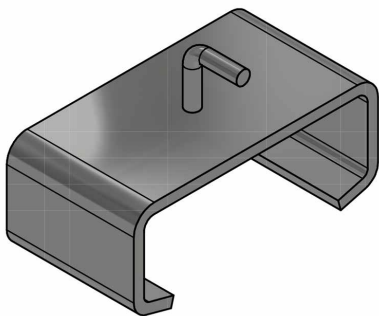

ITEM 1
ROD MOUNTED "C" CLIP

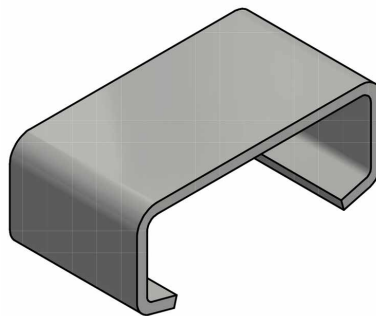

ITEM 2
PLAIN "C" CLIP

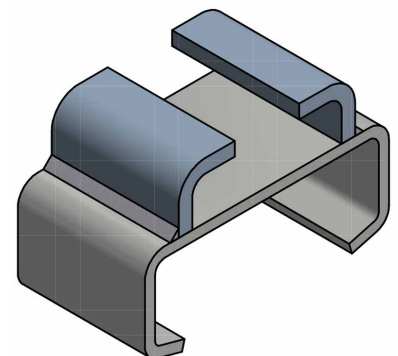

ITEM 3
"I" BEAM MOUNTED "C" CLIP

DESIGNATION

MANUFACTURED IN MILD STEEL

304 S/STL

316 S/STL

310 S/STL

L = 25mm - 350mm

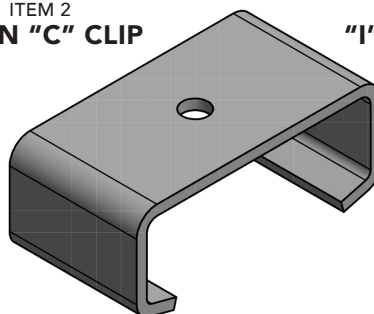

ITEM 4
HOLE TYPE "C" CLIP

R6P SUSPENSION

R6P ANCHOR USED TOO SUPPORT MESH

NOTES

Diameters Available: 5.5mm, 8mm, 10mm and 12mm

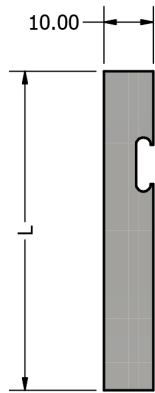

FRONT VIEW

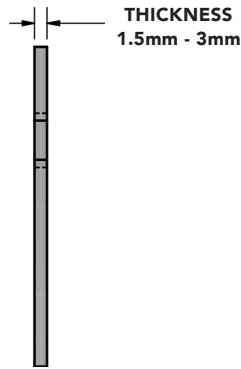

SIDE VIEW

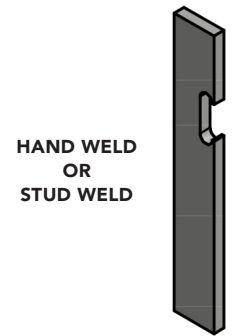

3D VIEW

HAND WELD
OR
STUD WELD

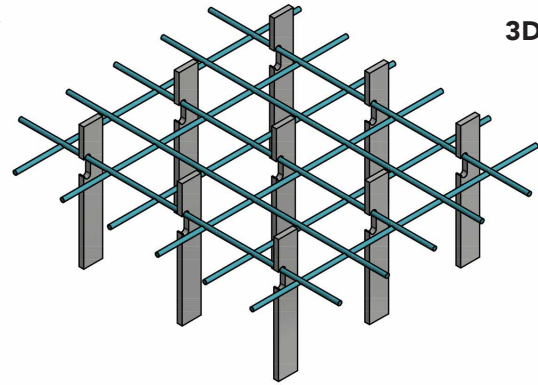

DESIGNATION

MANUFACTURED IN

304 S/STL

316 S/STL

310 S/STL

253 MA

L = 25mm - 350mm

S.A. SUSPENSION ANCHOR

NOTES

Diameters Available: 5mm, 8mm, 10mm and 12mm

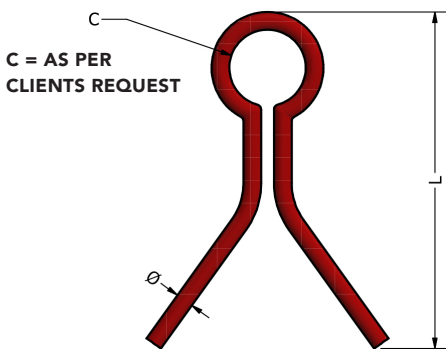

FRONT VIEW



SIDE VIEW

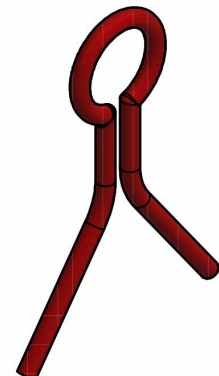

3D VIEW

DESIGNATION

MANUFACTURED IN MILD STEEL

304 S/STL

316 S/STL

310 S/STL

253 MA

L = 25mm - 350mm

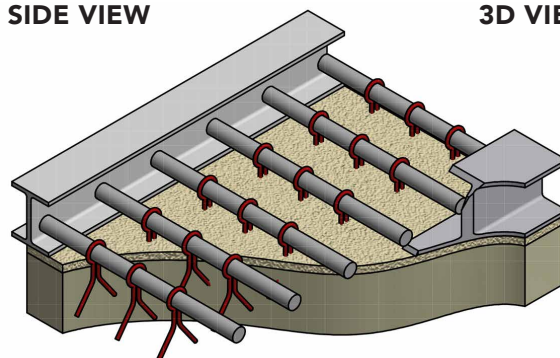

Y ANCHOR

WELDED 'Y' ANCHOR

NOTES

Diameters Available: 5.5mm, 8mm, 10mm and 12mm

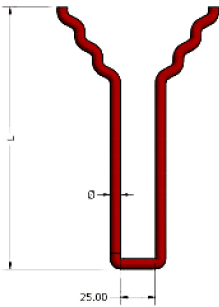

FRONT VIEW



SIDE VIEW

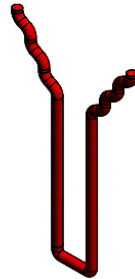

3D VIEW

DESIGNATION

MANUFACTURED IN MILD STEEL

304 S/STL

316 S/STL

310 S/STL

L = 25mm - 350mm



FRONT VIEW

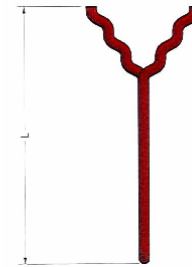

SIDE VIEW



3D VIEW

TYPICAL ANCHOR PATTERNS

NOTES

Diameters Available: 5.5mm, 8mm and 10mm

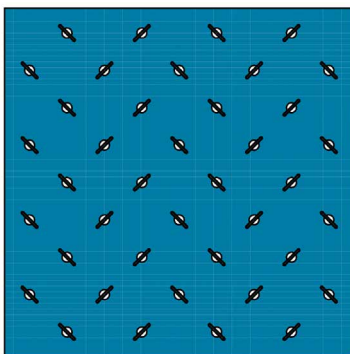

STAGGERED

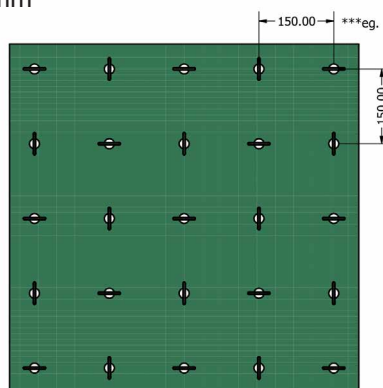

SQUARE

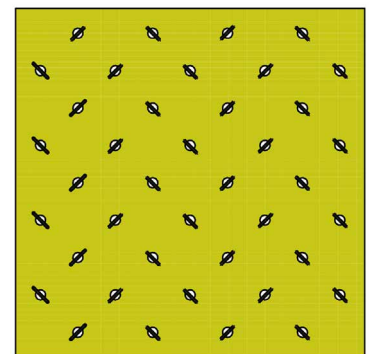

DIAMOND

DESIGNATION

MANUFACTURED IN MILD STEEL

304 S/STL

316 S/STL

310 S/STL

253 MA

L = 25mm - 350mm

***eg.

'CENTRE TO CENTRE' ANCHOR													
75	100	120	150	175	200	225	250	275	300	325	350	375	400
ANCHORS REQUIRED FOR 'SQAURE METER PATTERN'													
170	100	65	40	30	24	20	15	12	10	9	8	6	5



DICKINSON INDUSTRIES
www.dgrpint.com

T +27 (0) 16 421 3720
F +27 (0) 16 422 1038
E sales@dgrpint.com
E anchors@dgrpint.com
10 Smuts Avenue, Vereeniging, South Africa, 1930

